

*Два секретни успіху:  
якість та креативність*

*Пол Бокюз*

**TUPAI**

РУЧКИ

	293 R .....	29
	704 .....	34
	738R .....	30
	881 .....	34
	940R .....	30
	1908R .....	28
	1911 .....	35
	1917R .....	28
	1921Q .....	20
	1921RT .....	13
	1927R .....	29
	1938R .....	28
	1948R .....	31
	1964Q .....	18
	2275Q .....	19
	2275RT .....	13
	2282 .....	35
	2288R .....	29
	2730Q .....	18

РУЧКИ

	2732Q .....	21
	2732R .....	31
	2732RT .....	12
	2736Q .....	21
	2737Q .....	20
	3033Q .....	18
	3039RT .....	9
	3044Q .....	19
	3084RT .....	7
	3089RT .....	8
	3094RT .....	14
	3095Q 5S .....	24
	3097Q .....	20
	3097R .....	30
	3097RT .....	12
	3098Q .....	21
	3098R .....	31
	3098R 5S .....	25
	3098RT .....	12
	3099RT .....	14
	4006R 5S .....	25
	4007Q 5S .....	24
	4084RT .....	14
	серія RT .....	37
	серія Q .....	37
	серія R .....	39
	серія 5S .....	38

РОЗЕТКИ

**JNF**

РУЧКИ

	IN.00.001 .....	49
	IN.00.157 .....	47
	IN.00.169 .....	49
	IN.00.185 .....	47
	IN.00.240 .....	42
	IN.00.241 .....	45
	IN.00.242 .....	45
	IN.00.301 .....	42
	IN.00.310 .....	45
	IN.00.350 .....	42
	IN.00.410 .....	47
	IN.00.420 .....	43
	IN.00.421 .....	44
	IN.00.422 .....	44
	IN.00.426 .....	44
	IN.04.R .....	54
	IN.04.Q .....	55

РОЗЕТКИ

**METAL-BUD**

РУЧКИ

	CHIARA .....	58
	TOSKA .....	58
	ROMA .....	58
	IBIZA .....	59
	TOPAZ .....	59
	ELEKTRA .....	59
	.....	61

РОЗЕТКИ

**РУЧКИ ДО РОЗСУВНИХ ДВЕРЕЙ**

	Ручки до розсувних дверей JNF .....	64-69
	Ручки до розсувних дверей TUPAI .....	71
	Ручки до розсувних дверей PAMAR .....	70
	Ручки до скляних розсувних дверей JNF .....	74-75

**СИСТЕМИ ВІДКРИВАННЯ ДВЕРЕЙ**

	Система ERGON .....	82
	Система ARGENTA Pivotica .....	83
	Система JNF Pivotica .....	84
	Система MAGIC .....	85
	Система JNF .....	86-88
	Система VALCOMP Herkules .....	89
	Петля ANSELMI .....	90
	Петля Kubica .....	90
	Петля OTLAV .....	91

**АКСЕСУАРИ ДО ДВЕРЕЙ**

	Ковпачки .....	77
	Відбійники .....	78-79

**MINIMAL LINE**

	TUPAI 5S, розетка 5 mm .....	24-25
	JNF Even Less, розетка 1 mm .....	50-51

**СТЕНДИ**

	.....	94
--	-------	----











3084 RT/96

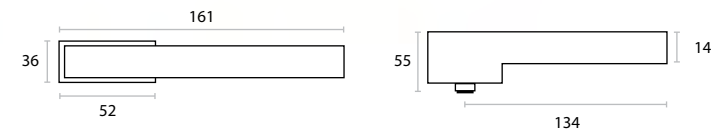

ІНСЕРТИ



3503 (натуральний камінь)



44 3277 (Swarovski elements)



46 3277 (Swarovski elements)



47 3277 (Swarovski elements)



48 3277 (Swarovski elements)



49 3277 (Swarovski elements)

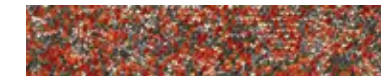

50 3277 (Swarovski elements)



57 3277 (Swarovski elements)

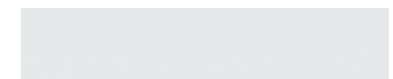

3084 BP (білий гляцевий)

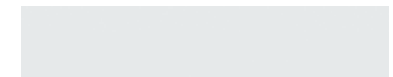

3084 BM (білий матовий)



3084 RED (червоний)



3084 CM (чорний матовий)



3084 CP (чорний гляцевий)

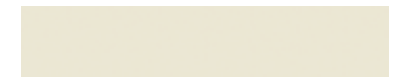

3084 EP (бежевий)



3084 OR (помаранчевий)



3084 PP (сірий гляцевий)



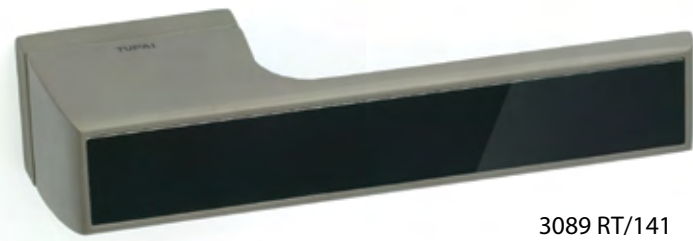

3089 RT/141

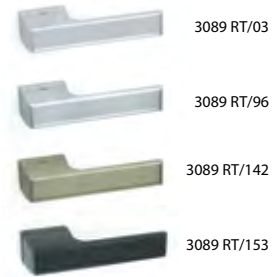

3089 RT/03

3089 RT/96

3089 RT/142

3089 RT/153

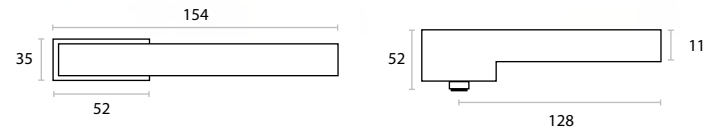

1985RT OB 3045RT WC 1999Q PZ

ІНСЕРТИ



3089 VM (білий матовий)



46 3276 (Swarovski elements)



46 3276 (Swarovski elements)



47 3276 (Swarovski elements)



48 3276 (Swarovski elements)



49 3276 (Swarovski elements)

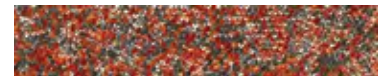

50 3276 (Swarovski elements)

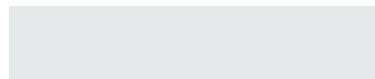

3089 VP (білий глянцевий)



3089 RED(червоний)



3089 CM (чорний матовий)



3089 CP (чорний глянцевий)

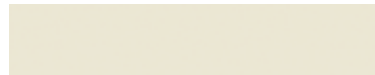

3089 EP(бежевий)



3089 OR (помаранчевий)



3089 PP (сірий глянцевий)



3039 RT/142

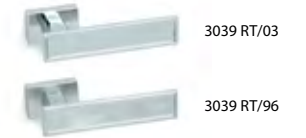

3039 RT/03

3039 RT/96

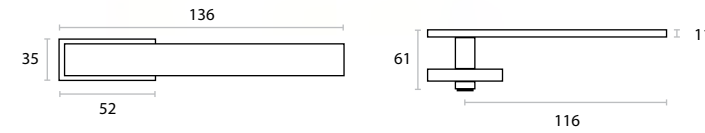

1985RT OB 3045RT WC 1999Q PZ

ІНСЕРТИ



43 3268 (Swarovski elements)

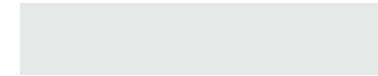

3039 VM (білий матовий)

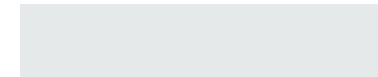

3039 VP(білий глянцевий)



3039 CM (чорний матовий)



3039 CP (чорний глянцевий)

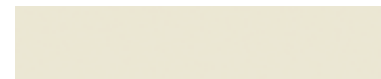

3039 EP (бежевий)



3039 OR (помаранчевий)



3039 PP (сірий глянцевий)



3039 RED (червоний)



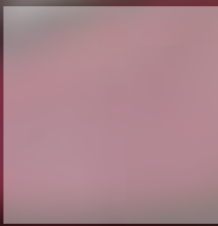
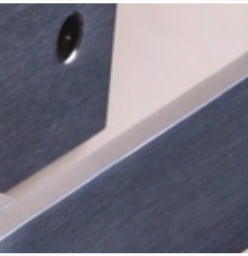

10 TUPAI

TUPAI





3097 RT 03 | 96 | 141 | 142



3097 RT/96

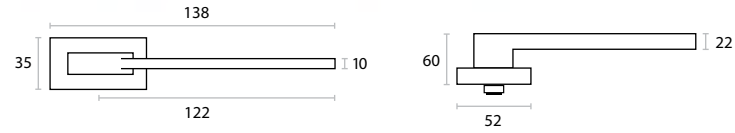

03 | 96 | 141 | 142 | 153 2275 RT



2275 RT/142

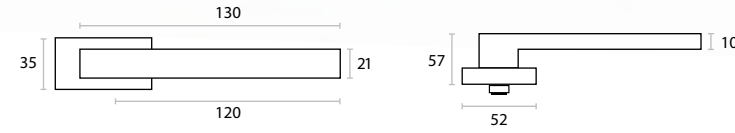

3098 RT 03 | 96 | 141 | 142



3098 RT/142



03 | 96 1921 RT



1921 RT/03

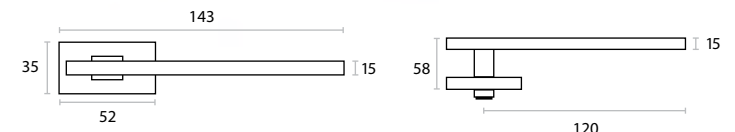

2732 RT 03 | 96 | 141 | 142 | 153



2732 RT/153

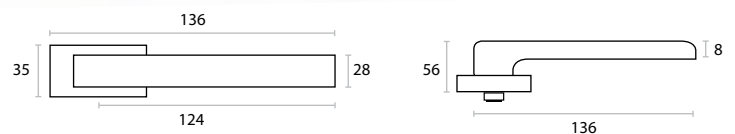



**3094 RT** 03 | 96 | 141 | 142 | 153



3094 RT/96

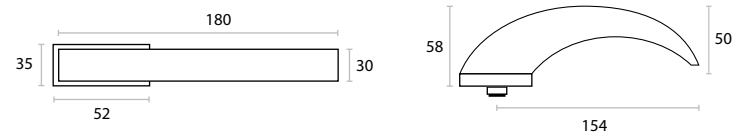

**4084 RT** 03 | 96 | 141 | 142 | 153



НОВИНКА  
4084 RT/141

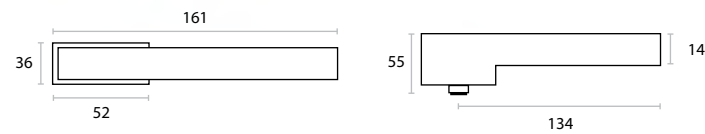

**3099 RT** 03 | 96 | 141 | 142 | 153



3099 RT/153

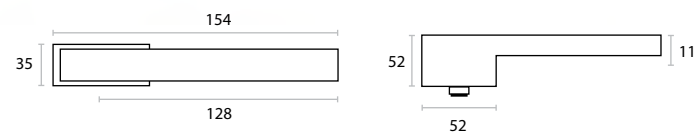







2730 Q 03 | 96 | 141 | 142 | 153



2730 Q/142

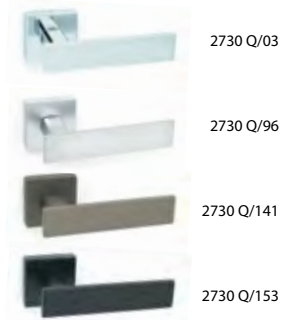
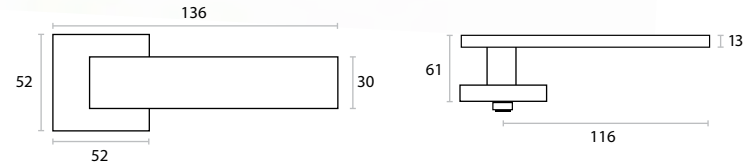

03 | 96 | 141 | 142 | 153 2275 Q



2275 Q/142

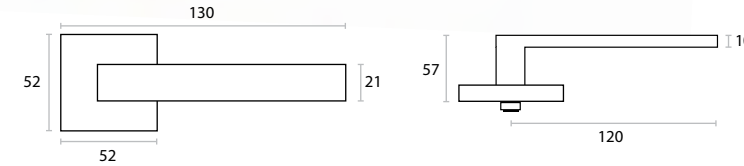

3033 Q 03 | 96

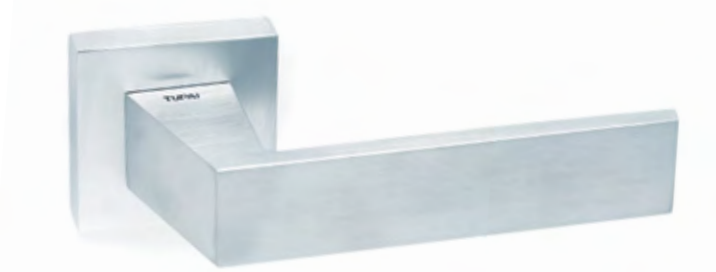

3033 Q/96

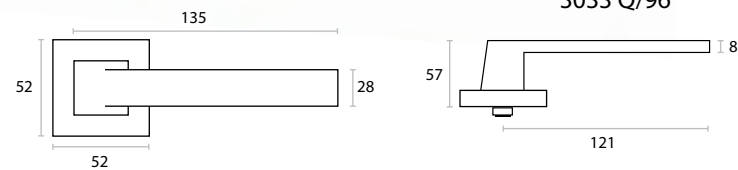

03 | 96 | 141 | 142 3044 Q



3044 Q/141

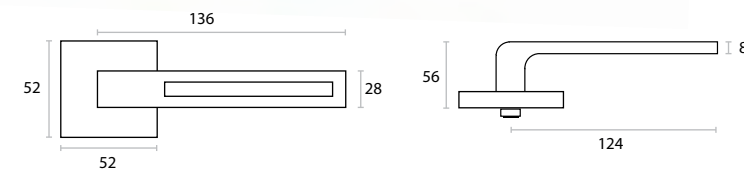

1964 Q 03 | 96



1964 Q/03

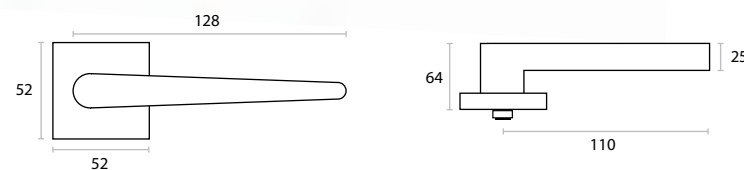



1921 Q 03 | 96

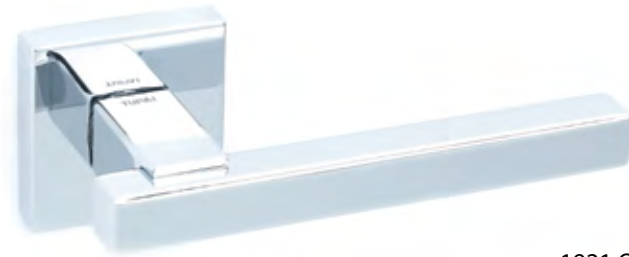

1921 Q/03

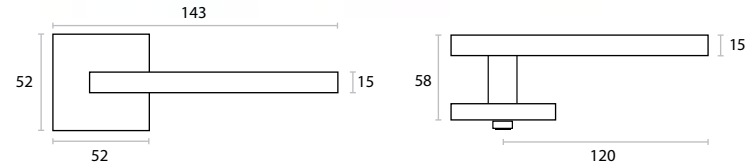

1921 Q/96



03 | 96 | 141 | 142 3098 Q



3098 Q/96

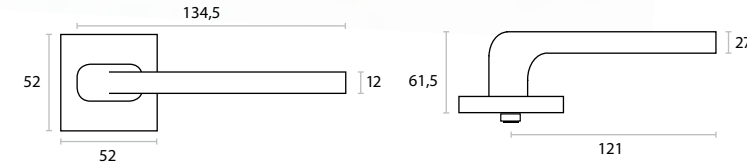

2737 Q 96 | 141 | 142



2737 Q/142

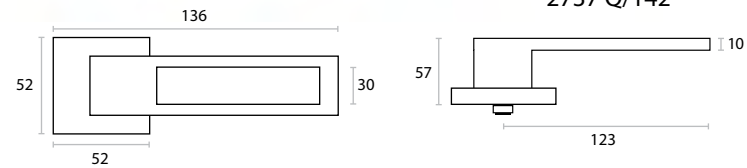

2737 Q/96

2737 Q/141



03 | 96 | 141 | 142 | 153 2732 Q



2732 Q/96

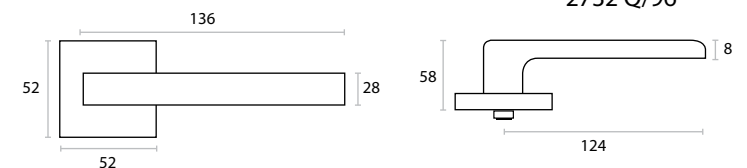

3097 Q 03 | 96 | 141 | 142



3097 Q/96

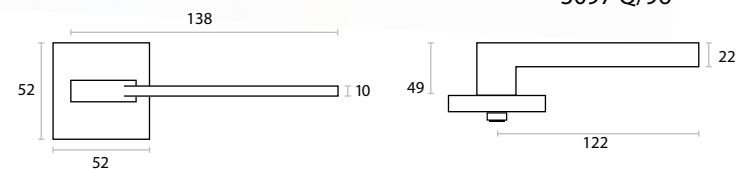

3097 Q/03

3097 Q/141

3097 Q/142



96 | 142 2736 Q



2736 Q/142

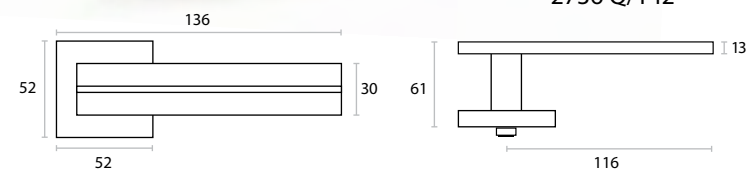

2736 Q/96





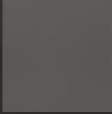
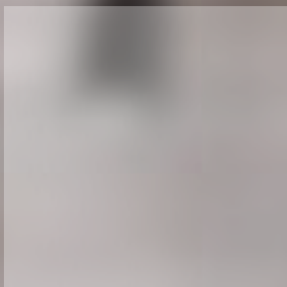
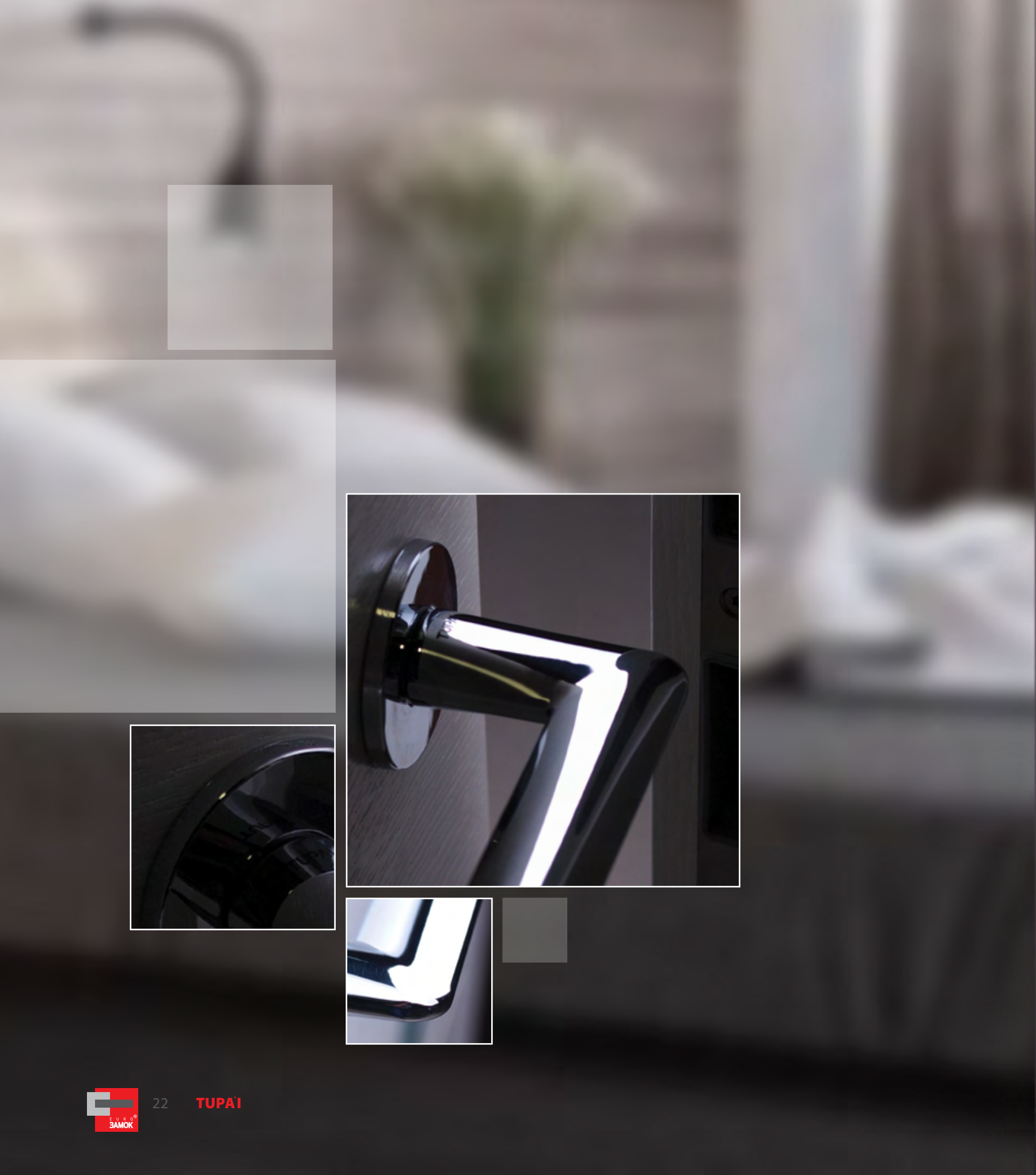

22

TUPAI

TUPAI



EURO  
ZAMOK



4007 Q-5S 01 | 03 | 49 | 96 | 142 | 152 | 153



4007 Q-5S/01



- 4007Q-5S/03
- 4007Q-5S/49
- 4007Q-5S/96
- 4007Q-5S/142
- 4007Q-5S/152
- 4007Q-5S/153

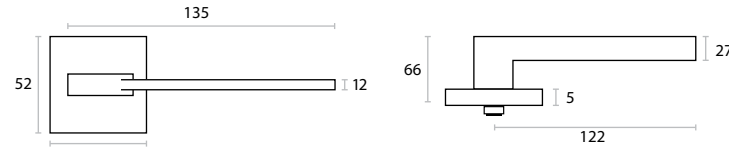

03 | 96 | 142 | 152 | 153 3098 R-5S



3098 R-5S/153



- 3098R-5S/03
- 3098R-5S/96
- 3098R-5S/142
- 3098R-5S/152



3095 Q-5S 01 | 03 | 49 | 96 | 142 | 152 | 153



3095 Q-5S/49



- 3095Q-5S/01
- 3095Q-5S/03
- 3095Q-5S/96
- 3095Q-5S/142
- 3095Q-5S/152
- 3095Q-5S/153

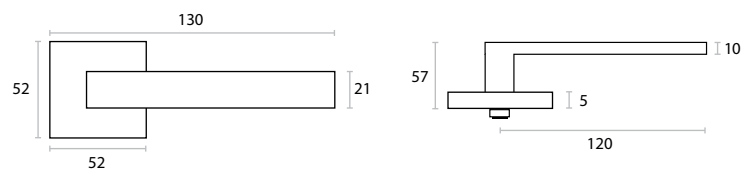

03 | 96 | 142 | 153 4006 R-5S



4006 R-5S/03



- 4006 R-5S/96
- 4006 R-5S/142
- 4006 R-5S/153

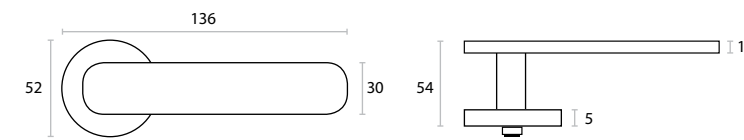







1908 R

01 | 03 | 77 | 142



1908 R/77

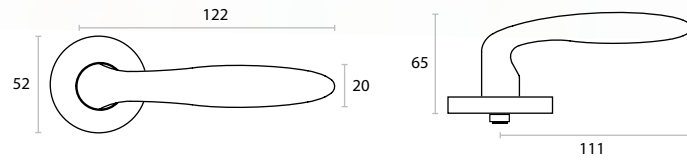

01 | 46 | 47 | 77

2288 R



2288 R/46

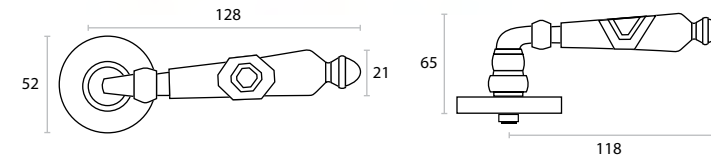

1938 R

01 | 03 | 77 | 142



1938 R/142

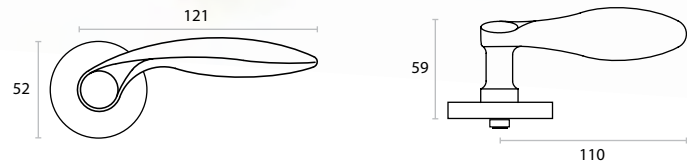

03 | 77 | 142

1927 R



1927 R/77

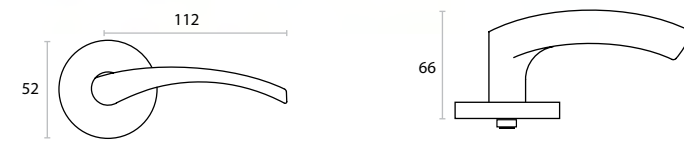

1917 R

01 | 46 | 47 | 77 | 142



1917 R/47

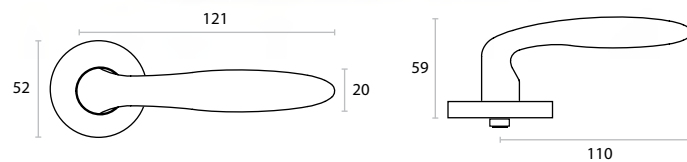

03 | 96 | 142 | 152 | 153

293 R



293 R/153

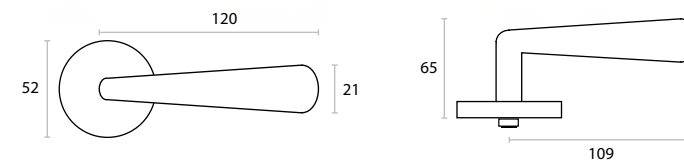



940 R

01 | 03 | 77 | 142



940 R/142

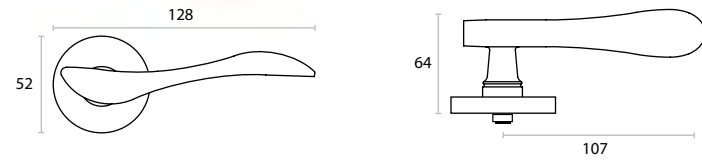

03 | 96 | 141 | 142

3098 R



3098 R/141



738 R

01 | 03 | 46 | 47 | 77 | 142



738 R/47

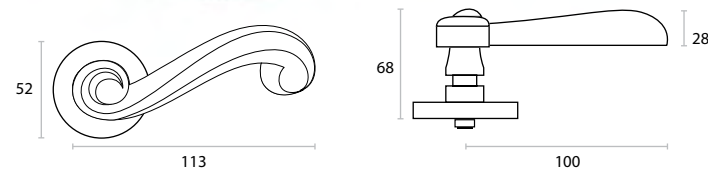

03 | 96 | 141 | 142 | 153

2732 R



2732 R/142

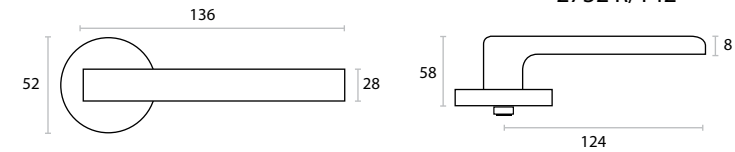

3097 R

03 | 96 | 141 | 142



3097 R/96

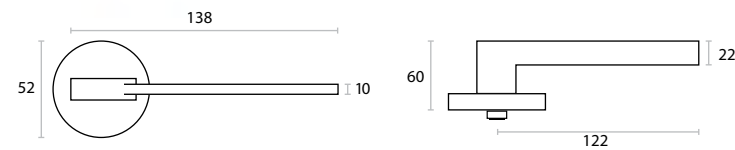

03 | 77

1948 R



1948 R/77

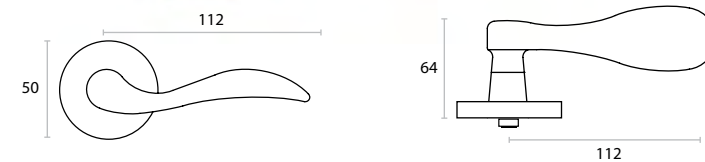







704

01 | 46 | 47 | 77 | 142

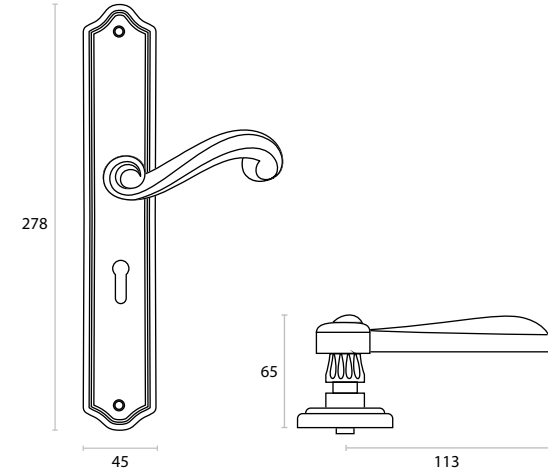

01 | 46 | 47 | 77 | 142

1911

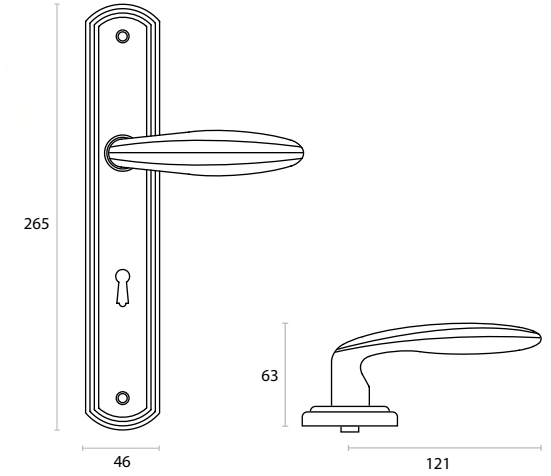

881

01

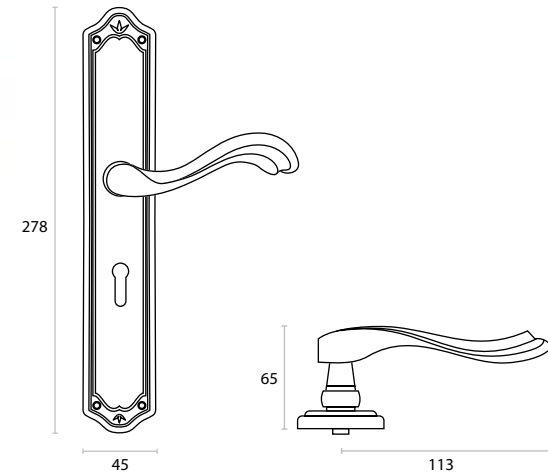

01 | 77

2282

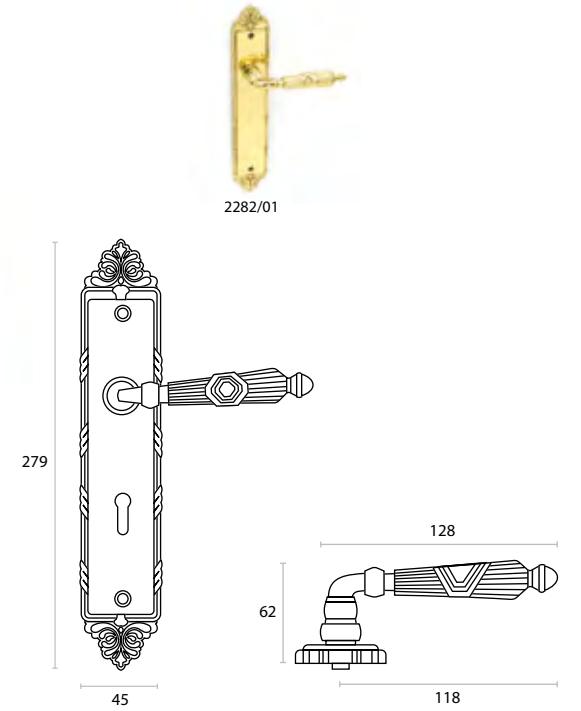





03 | 96 | 141 | 142 | 153 **1985 RT**



1985 RT/03

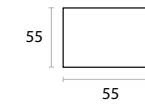

03 | 96 | 141 | 142 | 153 **3045 RT**



3045 RT/03

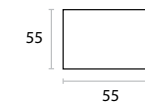

03 | 96 | 141 | 142 | 153 **1999 Q**



1999 Q/03

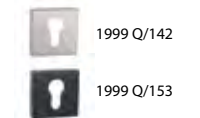
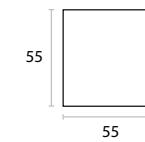

03 | 96 | 141 | 142 | 153 **1998 Q**



1998 Q/03

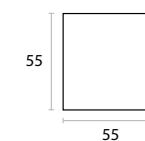

03 | 96 | 141 | 142 | 153 **801 Q**



801 Q/03

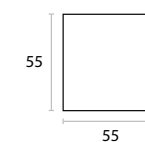



4049 Q 5S 01 | 03 | 49 | 96 | 142 | 152 | 153



4049 Q/03

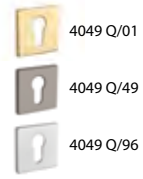
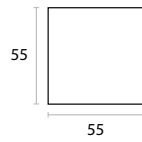

4049 Q/01

4049 Q/49

4049 Q/96

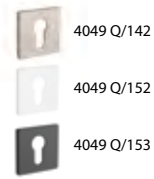

4049 Q/142

4049 Q/152

4049 Q/153

4040 Q 5S 01 | 03 | 49 | 96 | 142 | 152 | 153



4049 Q/03

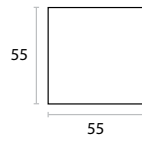

4049 Q/01

4049 Q/49

4049 Q/96



4049 Q/142

4049 Q/152

4049 Q/153

4048 Q 5S 01 | 03 | 49 | 96 | 142 | 152 | 153



4048 Q/03

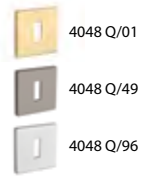
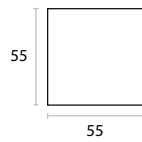

4048 Q/01

4048 Q/49

4048 Q/96



4048 Q/142

4048 Q/152

4048 Q/153

4046 R 5S 03 | 96 | 142 | 152 | 153



4046 R 5S/03

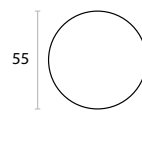

4046 R 5S/96

4046 R 5S/142

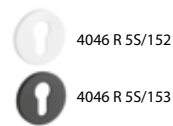

4046 R 5S/152

4046 R 5S/153

4041 R 5S 03 | 96 | 142 | 152 | 153



4041 R 5S/03

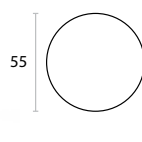

4041 R 5S/96

4041 R 5S/142

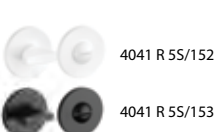

4041 R 5S/152

4041 R 5S/153

4045 R 5S 03 | 96 | 142 | 152 | 153 | 142



4045 R 5S/03

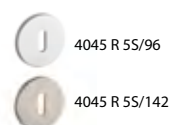
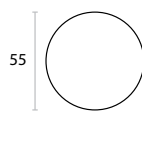

4045 R 5S/96

4045 R 5S/142

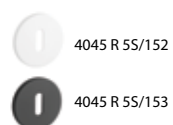

4045 R 5S/152

4045 R 5S/153

01 | 03 | 77 | 96 | 141 | 142 | 153

1966 R



1966 R/03

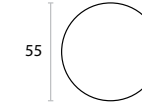

1966 R/01

1966 R/77

1966 R/96



1966 R/141

1966 R/142

1966 R/153

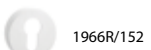

1966R/152

01 | 03 | 77 | 96 | 141 | 142 | 153

1965 R



1965 R/03

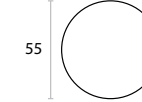

1965 R/01

1965 R/77

1965 R/96



1965 R/141

1965 R/142

1965 R/153

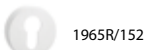

1965R/152

01 | 03 | 77 | 96 | 141 | 142 | 153

806 R



806 R/03



806 R/01

806 R/77

806 R/96



806 R/141

806 R/142

806 R/153



806 R/152

01 | 03 | 46 | 47 | 67 | 77 | 142

787 R



787 R/03



787 R/01

787 R/46

787 R/47



787 R/67

787 R/77

787 R/142

01 | 03 | 46 | 47 | 67 | 77 | 142

786 R



786 R/03



786 R/01

786 R/46

786 R/47



786 R/67

786 R/77

786 R/142

01 | 03 | 46 | 47 | 67 | 77 | 142

800 R



800 R/03



800 R/01

800 R/46

800 R/47



800 R/67

800 R/77

800 R/142

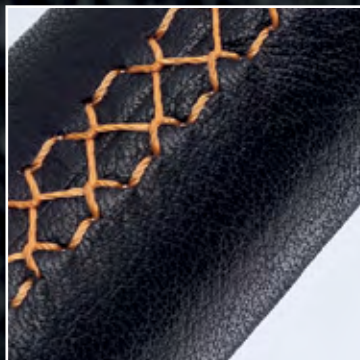



IN.00.240



IN.00.240

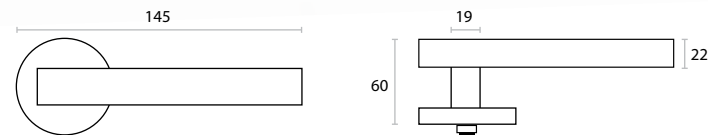

IN.00.350



IN.00.350

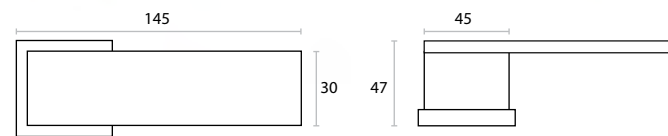

IN.00.301



IN.00.301

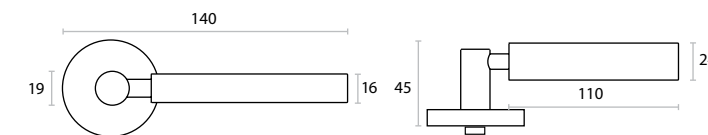

IN.00.420



IN.00.420

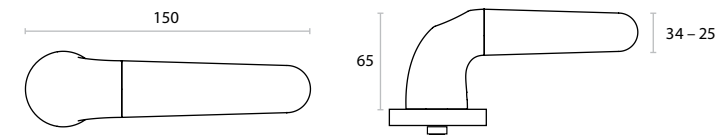

IN.00.421



IN.00.421

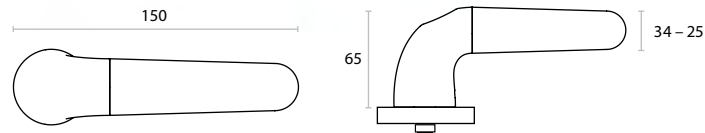

IN.00.421 P



IN.00.422



IN.00.422

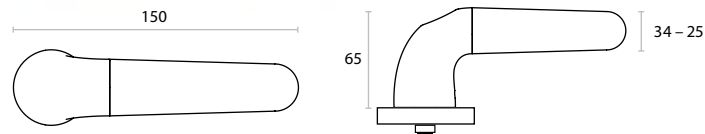

IN.00.422 P



IN.00.426



IN.00.426

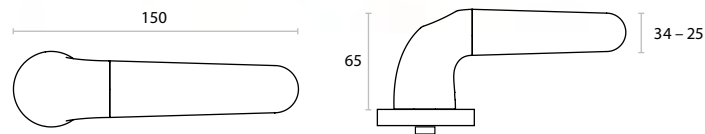

IN.00.426 P



IN.00.310



IN.00.310 · OUTLINE BLACK MATE

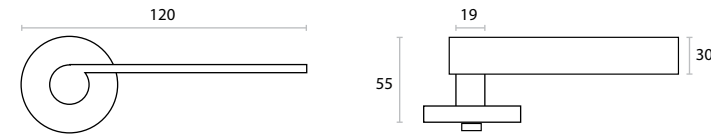

IN.00.311  
OUTLINE LIGHT GREY

IN.00.312  
OUTLINE MIRROR

IN.00.313  
OUTLINE DARK GREY

IN.00.314  
OUTLINE WHITE

IN.00.315  
OUTLINE JET



IN.00.241



IN.00.241 P

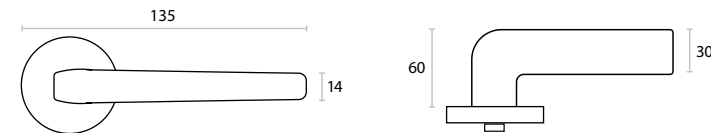

IN.00.242



IN.00.242

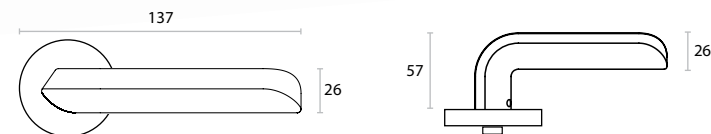

IN.00.242 P







IN.00.157



IN.00.157

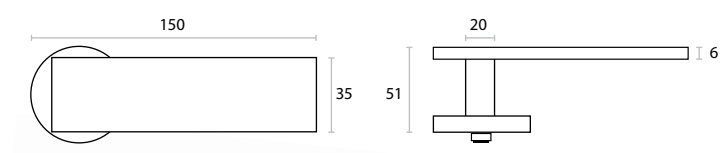

- IN.04.28R.P08.M
- IN.04.101
- IN.04.28R.Y08M

IN.00.410

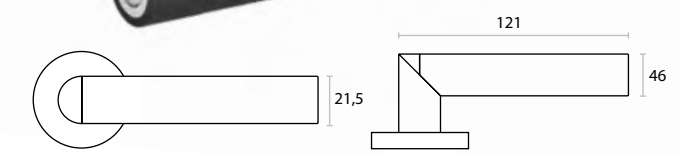

- IN.04.28R.P08.M
- IN.04.101
- IN.04.28R.Y08.M

IN.00.185

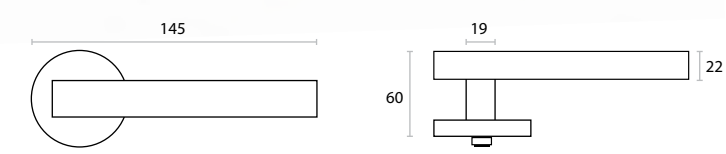

- IN.04.28R.P08.M
- IN.04.101
- IN.04.28R.Y08.M



SR.00.001



SR.00.001.B



SR.00.001.N



SR.00.001.C

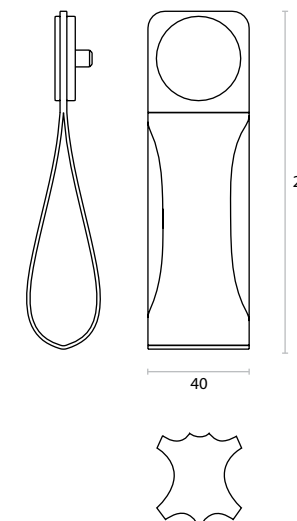

IN.00.169



IN.00.169.D



IN.00.169.TB



IN.00.169.TG



IN.00.169.TCO

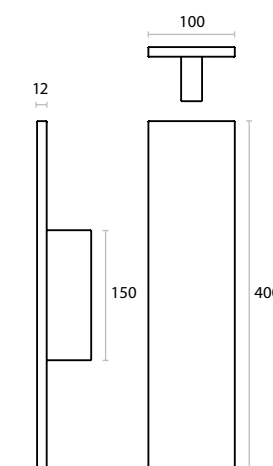



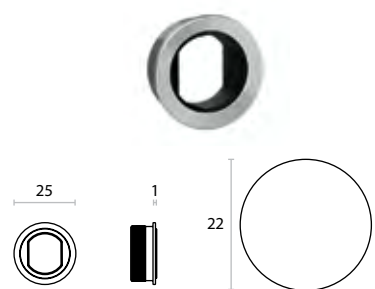
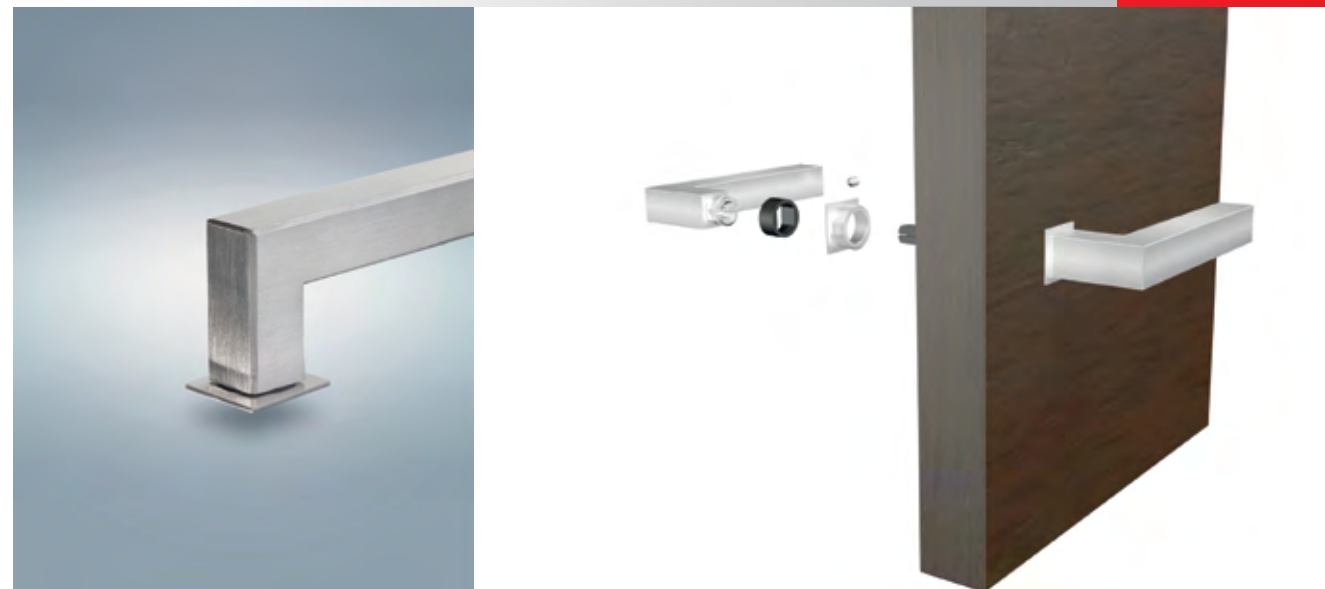
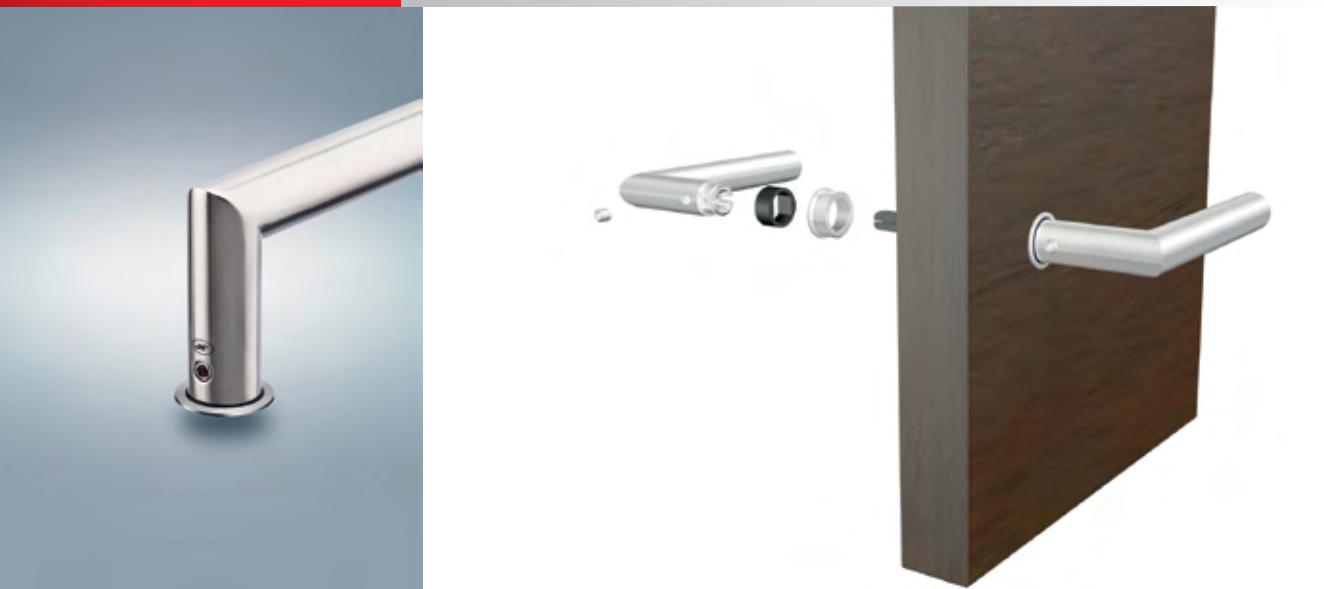

R01S EVEN LESS

IN.04.RP01S EVEN LESS

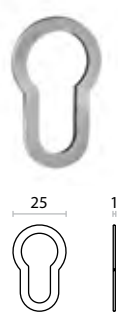

IN.04.RY01S EVEN LESS

IN.04.009 EVEN LESS

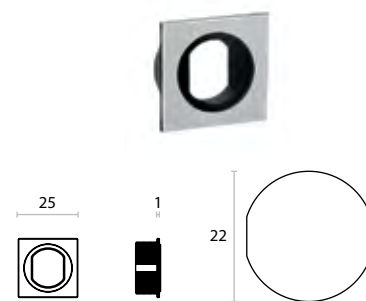
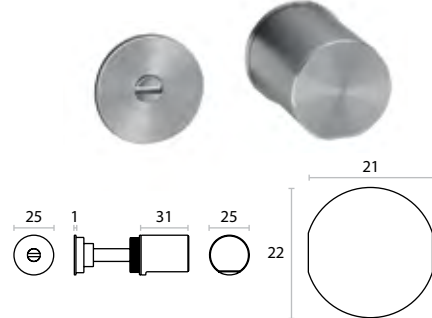
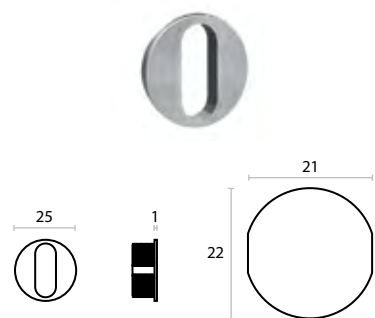

Q01S EVEN LESS

IN.04.QP01S EVEN LESS



IN.04.QY01S EVEN LESS

IN.04.010 EVEN LESS

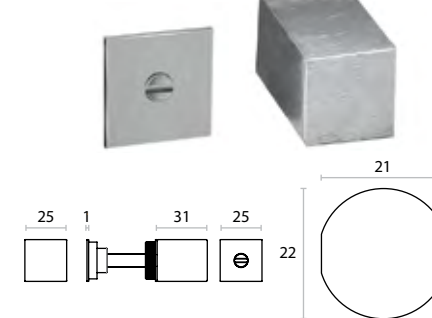
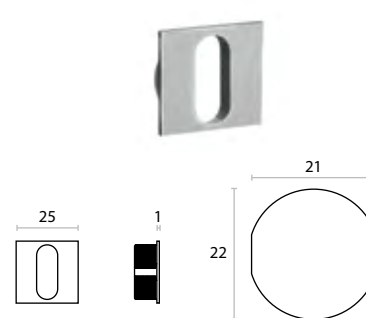

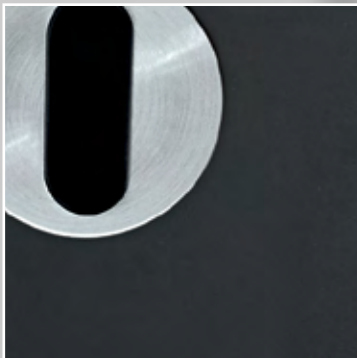



IN.04.28R.Y08

01 | 02 | 03 | 04



IN.04.28R.Y08

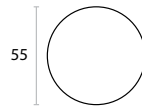

IN.04.28R.Y08 TB



IN.04.28R.Y08 TG



IN.04.28R.Y08 TCO

IN.04.101

01 | 02 | 03 | 04



IN.04.101



IN.04.101 TB



IN.04.101 TG



IN.04.101 TCO

IN.04.RY01MB

01 | 02 | 03 | 04



IN.04.RY01MB

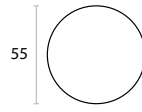

IN.04.RY01MB TB



IN.04.RY01MB TG



IN.04.RY01MB TCO

IN.04.004

01 | 02 | 03 | 04



IN.04.004

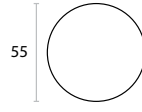

IN.04.004 TB



IN.04.004 TG



IN.04.004 TCO

IN.04.RY01S

01



IN.04.RY01S

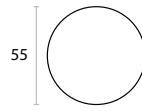

IN.04.009

01



IN.04.009

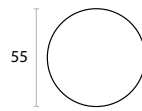

01 | 02 | 03 | 04

IN.04.QY03MB



IN.04.QY03MB

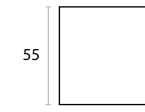

IN.04.QY03MB TB



IN.04.QY03MB TG



IN.04.QY03MB TCO

01 | 02 | 03 | 04

IN.04.014



IN.04.014

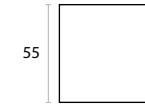

IN.04.014 TB



IN.04.014 TG



IN.04.014 TCO

IN.04.29Q.Y08N



IN.04.29Q.Y08N

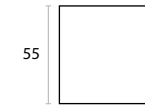

IN.04.29Q.Y08N TB



IN.04.29Q.Y08N TG



IN.04.29Q.Y08N TCO

01 | 02 | 03 | 04

IN.04.120



IN.04.120

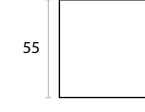

IN.04.120 TB



IN.04.120 TG



IN.04.120 TCO

01

IN.04.QY01S



IN.04.QY01S

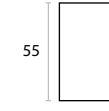

IN.04.010



IN.04.010

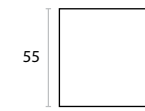



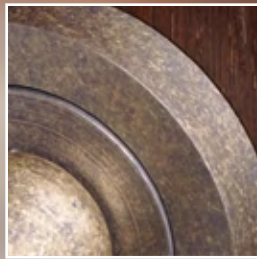



## CHIARA



Chiara (ZCOPA) антична бронза

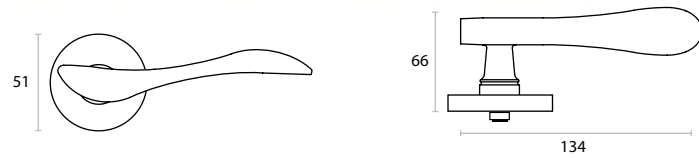

Chiara (ZCONA) античне срібло



стр. 61 стр. 61 стр. 61

## IBIZA



IBIZA (ZIBZG) графіт

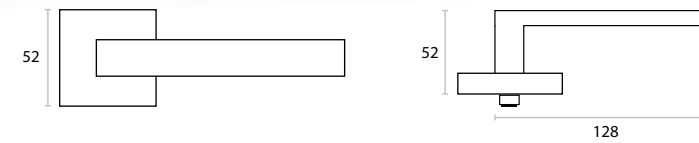

IBIZA (ZIBZS) срібло матове

IBIZA (ZIBZN) нікель матовий



стр. 61 стр. 61 стр. 61

## TOSCA



Tosca (ZTONA) античне срібло



Tosca (ZTOPA) антична бронза



стр. 61 стр. 61 стр. 61

## ТОПАЗ

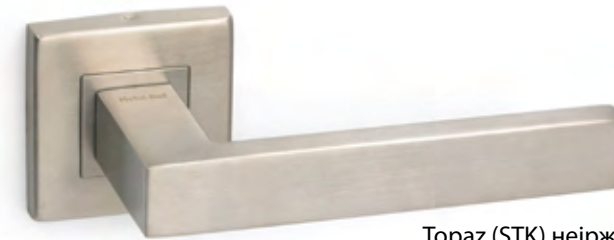

Topaz (STK) неіржавійка

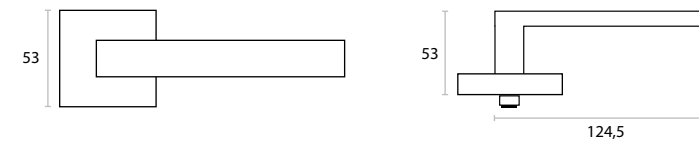

стр. 61 стр. 61 стр. 61

## ROMA



ROMA (RNO) неіржавійка

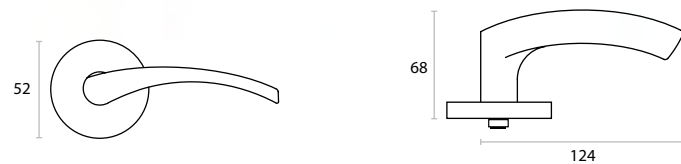

стр. 61 стр. 61 стр. 61

## ELEKTRA



ELEKTRA (ENOK) неіржавійка

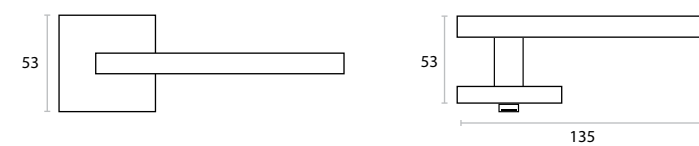

стр. 61 стр. 61 стр. 61



**SNOPA**

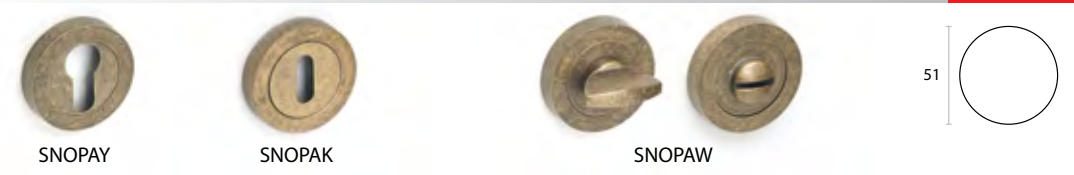

**SNONA**



**NN**



**SZZS**



**SZZG**



**SZZN**



**SSK**





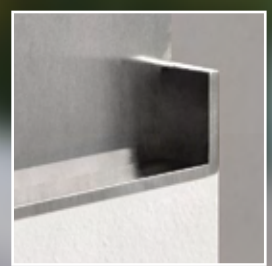
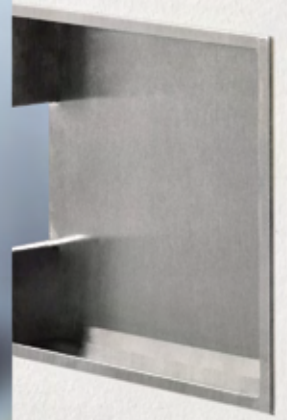
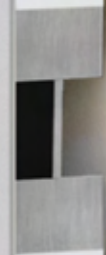

IN.16.223/ IN.16.224



IN.16.223



IN.16.224

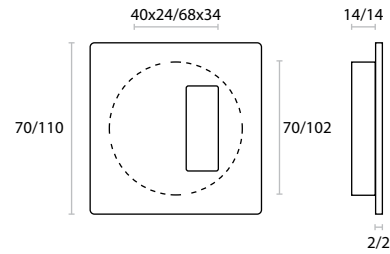
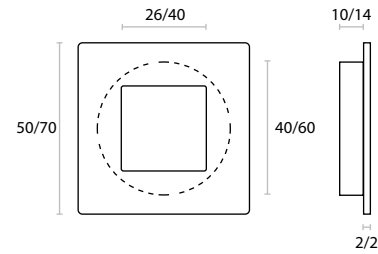

IN.16.404/ IN.16.400

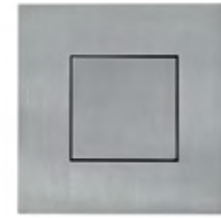

IN.16.404



IN.16.400

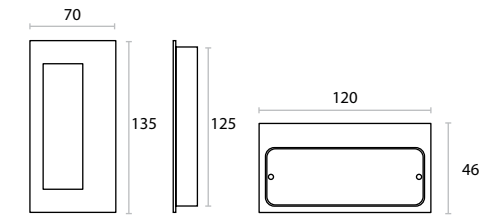
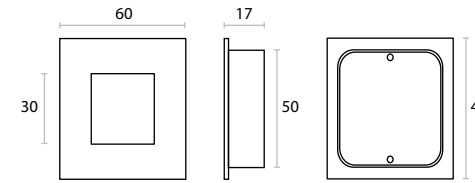

IN.16.225



IN.16.225



IN.16.225.TB

IN.16.225.TG

IN.16.225.TCO

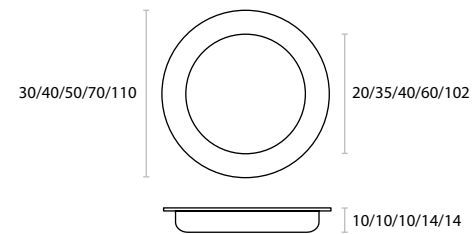

IN.16.402/ IN.16.406



IN.16.402



IN.16.406

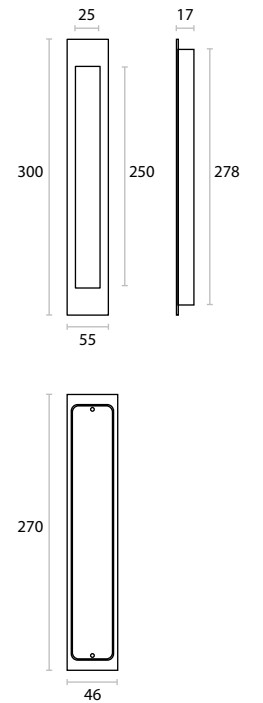
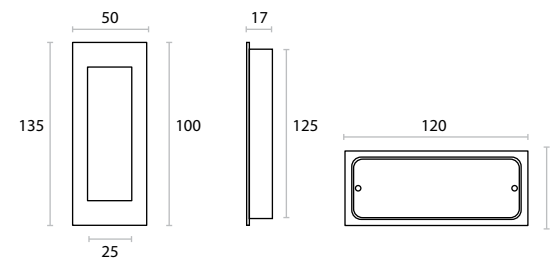



IN.16.237.600



IN.16.237.600

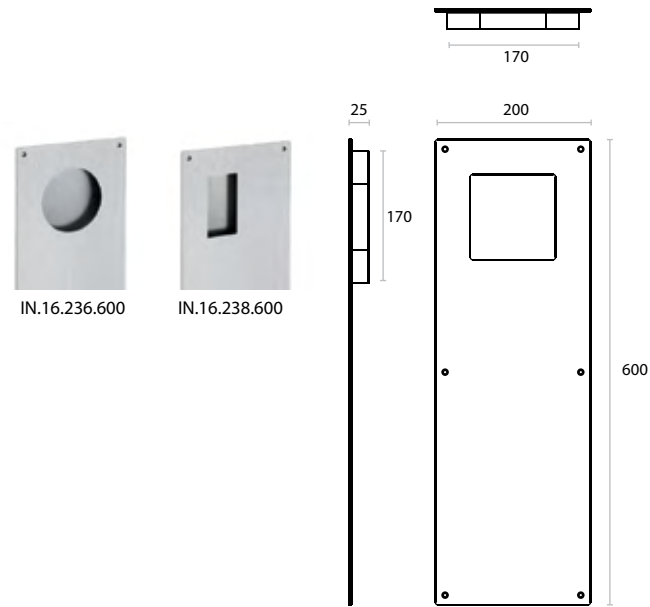

IN.16.236.600

IN.16.238.600

IN.16.410



IN.16.410



IN.16.410.TB

IN.16.410.TG

IN.16.410.TCO

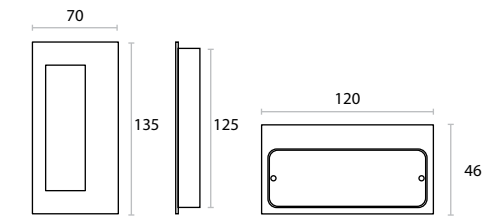

IN.16.412



IN.16.412



IN.16.412.TB

IN.16.412.TG

IN.16.412.TCO

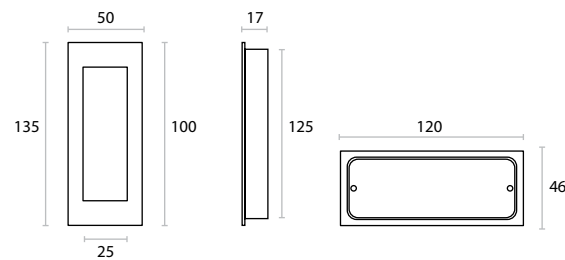

IN.16.416



IN.16.416



IN.16.416.TB

IN.16.416.TG

IN.16.416.TCO

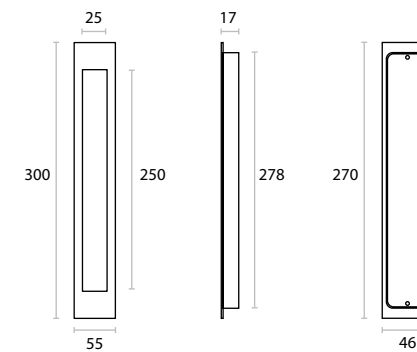

IN.16.312/IN.16.317

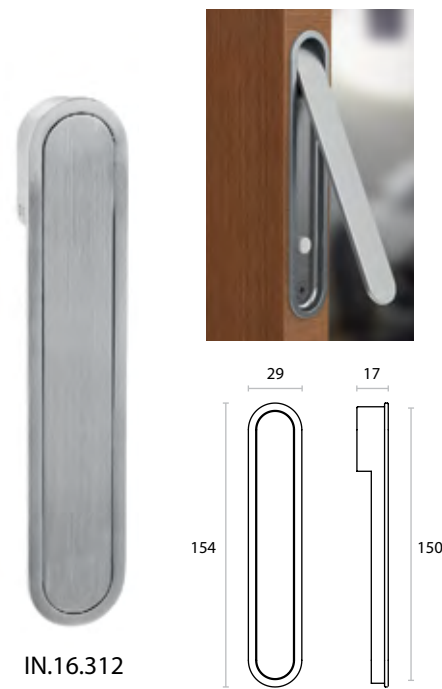

IN.16.301



IN.16.301.35  
IN.16.301.40

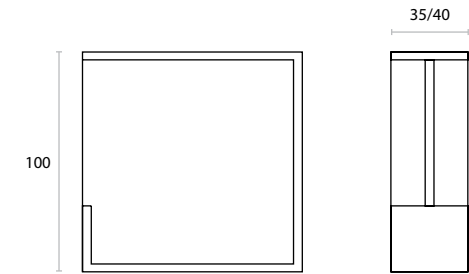

IN.16.314/IN.16.315



IN.16.314

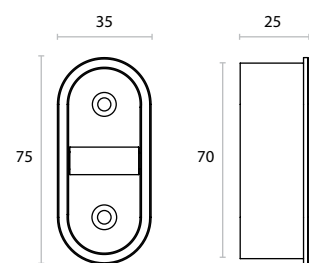

IN.16.315

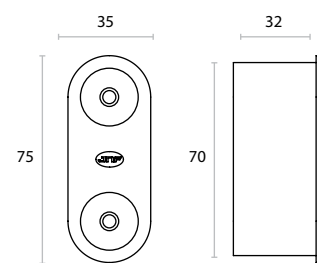

IN.16.300



IN.16.300.35  
IN.16.300.40

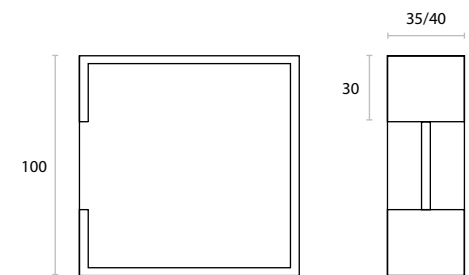



1100Z PZ



1100Z PZ 96



1100Z PZ 142 1100Z PZ 153

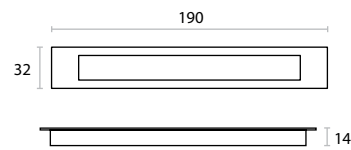

1695 / 1696



TUPA'I 1695-16

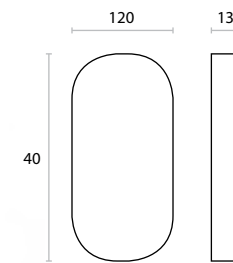

TUPA'I 1696-16

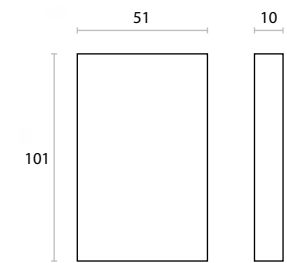

1096Z WC



1096Z WC 96



1096Z WC 142 1096Z WC 153

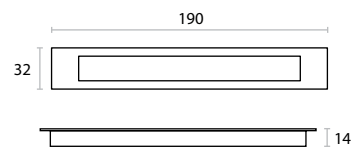

03 | 51 | 52 | 96 | 128

2650



TUPA'I 2650-128



TUPA'I 2650-51



TUPA'I 2650-52



TUPA'I 2650-96



TUPA'I 2650-03

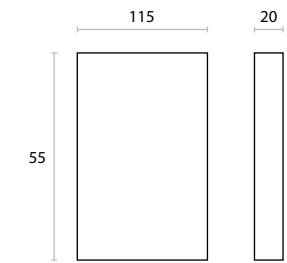

1098Z UG



1098Z UG



1098Z UG 142 1098Z UG 153

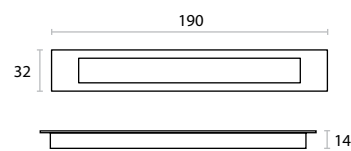

1697 / 7503



TUPA'I 1697-16

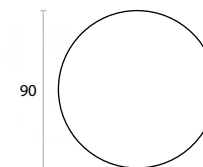

ATZ 7503-16

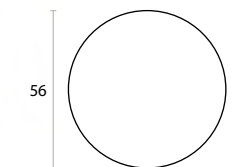

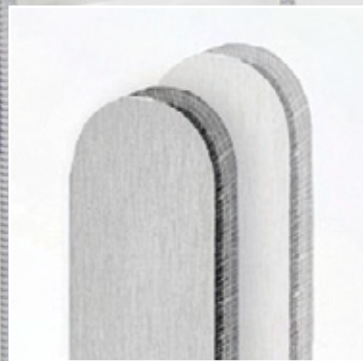
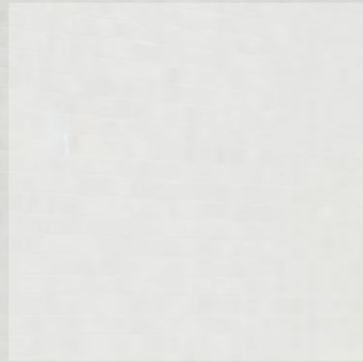



IN.16.557/ IN.16.555

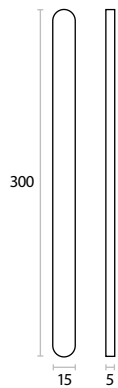

IN.16.557

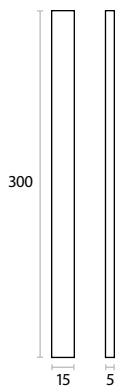

IN.16.555

IN.16.559/ IN.16.558

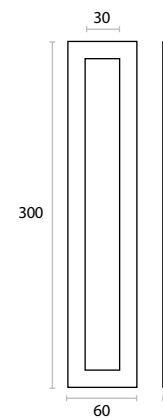

IN.16.559

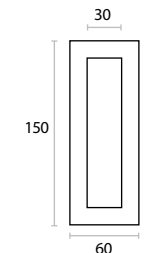

IN.16.558

IN.16.561/ IN.16.565

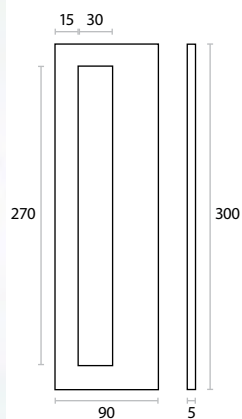

IN.16.561

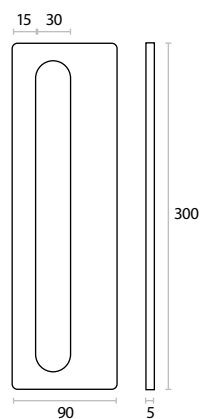

IN.16.565

IN.16.563/ IN.16.562

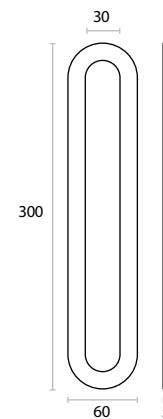

IN.16.563

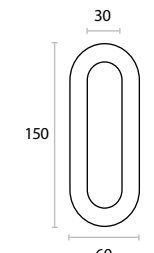

IN.16.562



КОВПАЧКИ



Z336SN (ONS)



Z336PB (OLV)



Z336CP (OCL)



Z336AB (OGR)



Z337SN (ONS)



Z337PB (OLV)



Z337CP (OCL)



Z337AB (OGR)



METAL-BUD OZ14N (ONS)



METAL-BUD OZ14M (OLV)



METAL-BUD OZ14C (OCL)



METAL-BUD OZ14P (OGR)



TUPAI T14-96



TUPAI T14-142



TUPAI T14-141



TUPAI T14-153



NA1



NA2



NA3



NA5



NA6



NA6A



NA7



NA2C





ARBO 1905BL



ARBO 1905BR



ARBO 1905BEZ



ARBO 5283C



HANDMET Z380B



HANDMET Z380S



HANDMET Z380C



ARBO 5283BR



JNF IN.13.186



JNF IN.23.009



JNF IN.23.127



JNF IN.13.111.35



TUPAI 2617Q-96 · 20\*20\*32 мм



TUPAI 2617Q-141 · 20\*20\*32 мм



TUPAI 2617Q-142 · 20\*20\*32 мм



TUPAI 2617Q-153 · 20\*20\*32 мм



TUPAI 115-141 · Ø20; h27 мм



TUPAI 115-142 · Ø20; h27 мм



TUPAI 2617Q-03 · 20\*20\*32 мм



TUPAI 2617Q-77 · 20\*20\*32 мм



TUPAI 115-01 · Ø20; h27 мм



TUPAI 115-03 · Ø20; h27 мм



TUPAI 115-77 · Ø20; h27 мм



TUPAI 115-96 · Ø20; h27 мм



TUPAI 1699-58 · Ø22; h30 мм  
TUPAI 1699-16



TUPAI 1623-16 · Ø28; h44 мм



TUPAI 2260Q 16 · 20\*20\*32 мм



TUPAI 2261Q-16 · 25\*25\*42 мм

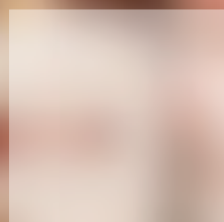





Система **Ergon Living** є інноваційною системою до дверей, яка дозволяє краще використовувати простір в залежності від потреби, двері працюють у дві сторони.

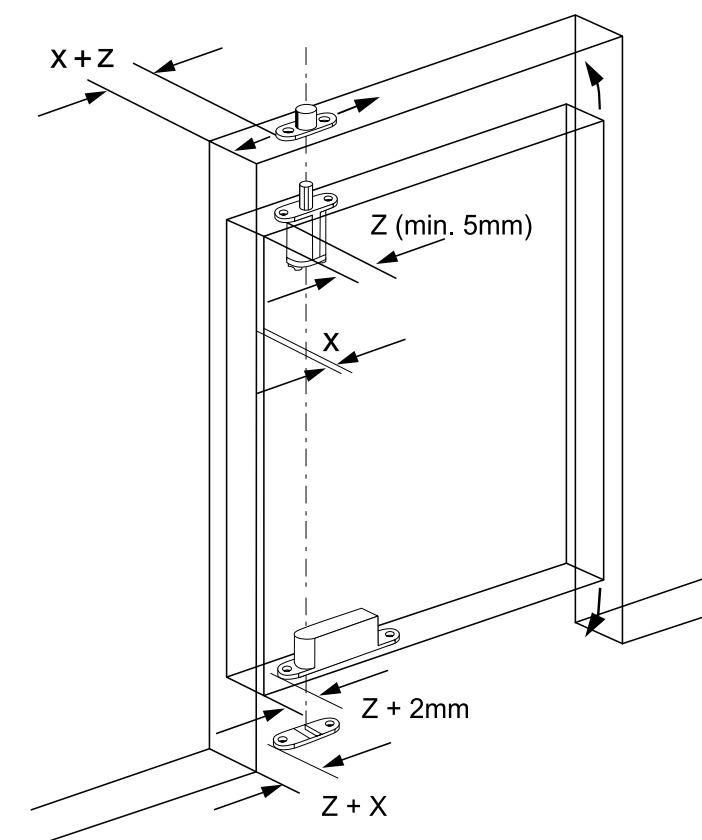

Завіси **Pivotica** дозволяють монтувати двері без коробки. При цьому вісь обертання можна зміщувати.

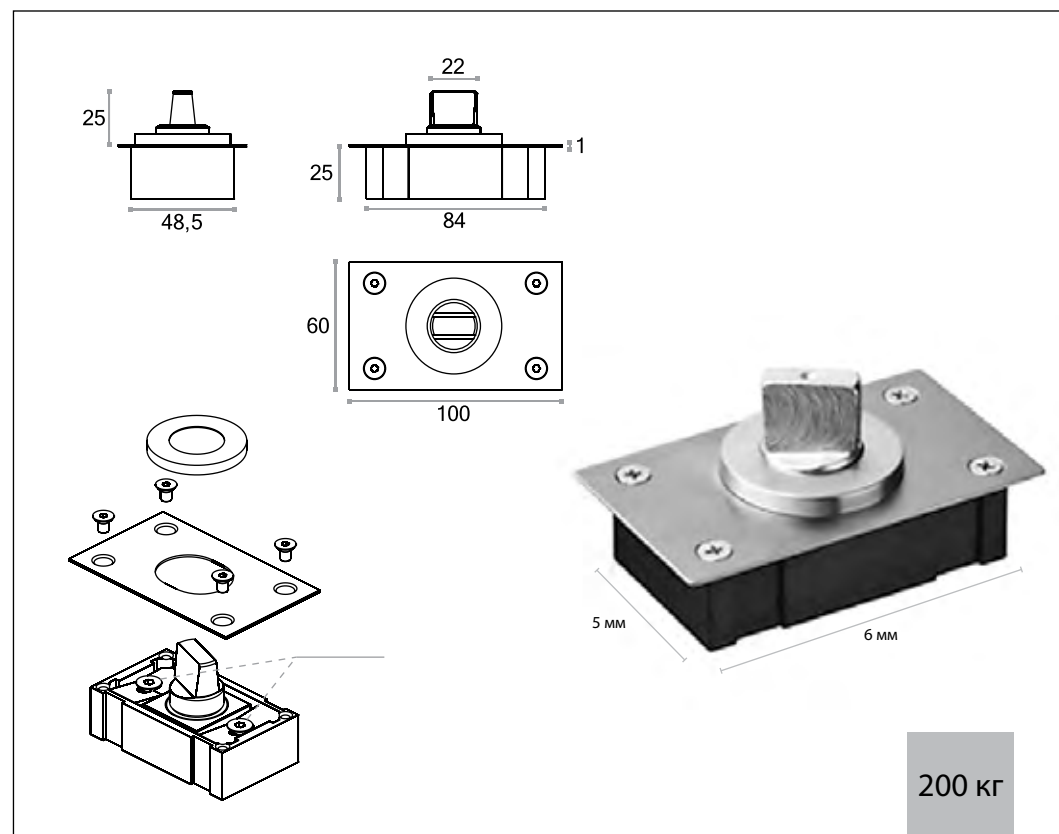
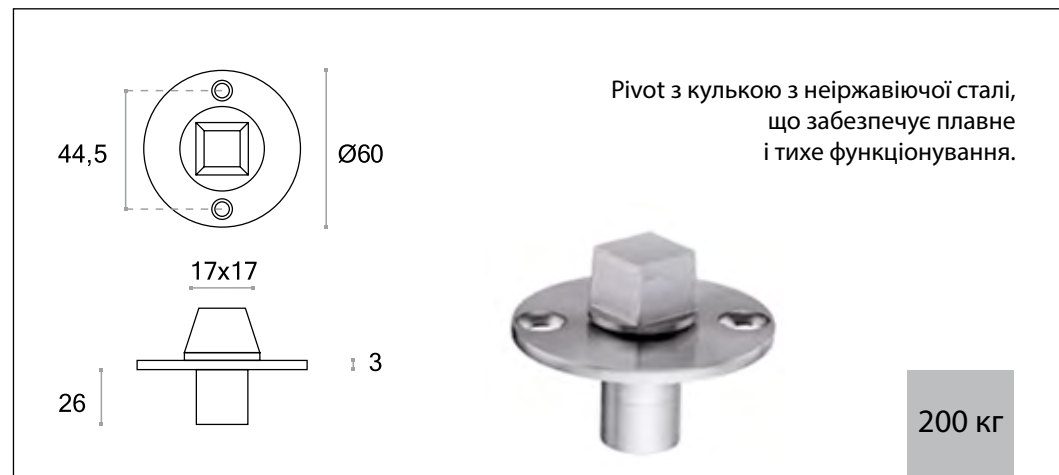

Нова «невидима» розсувна система – виняткове рішення для дерев'яних та скляних дверей. Це інноваційний, запатентований механізм, в якому верхня і нижня направляючі приховані. При відкритих і закритих дверях механізм залишається невидимим.

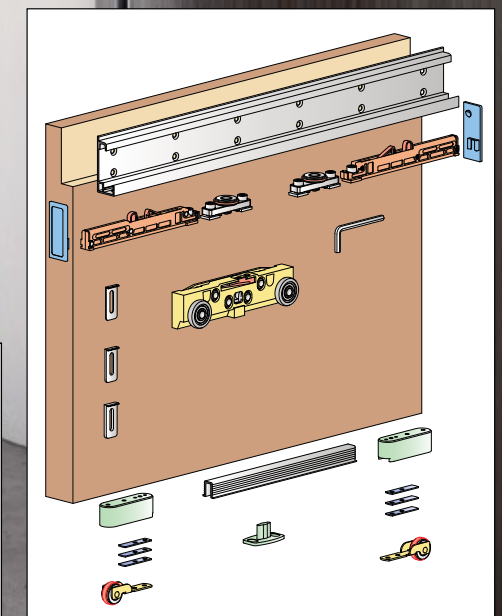



JNF15.900/ JNF 15.901

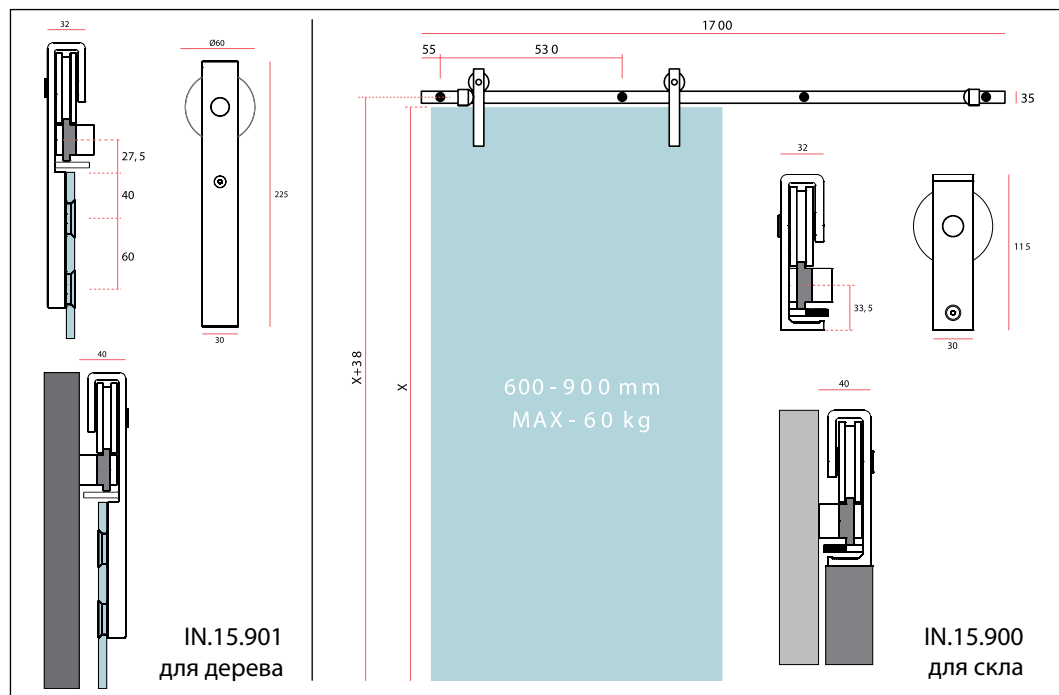

JNF 15.200 / JNF 15.205

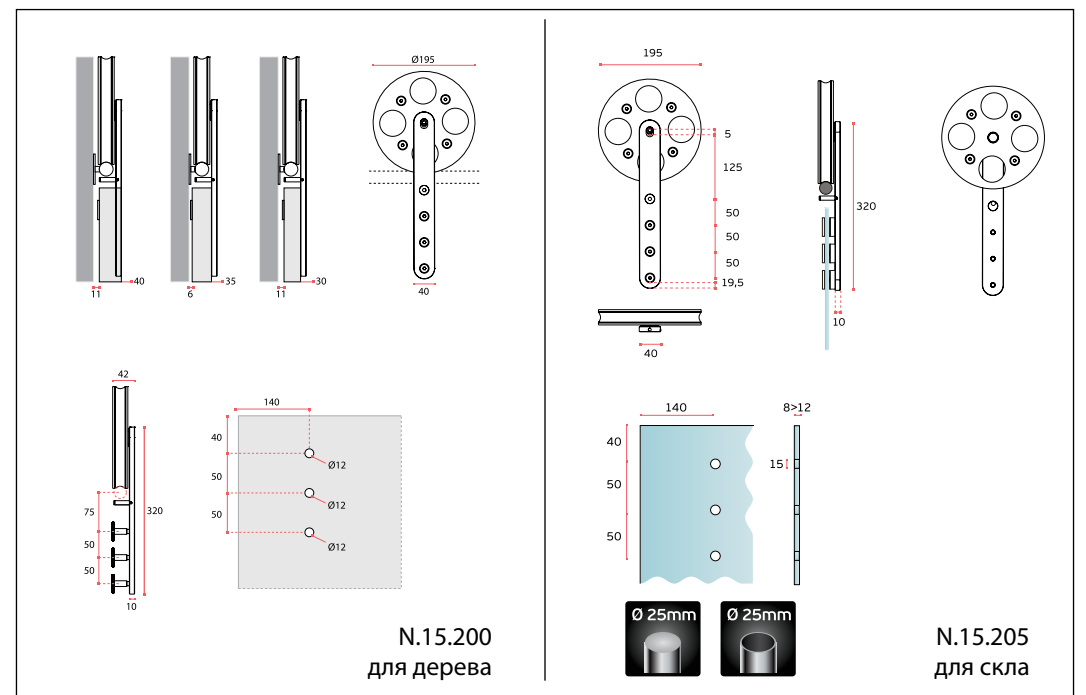
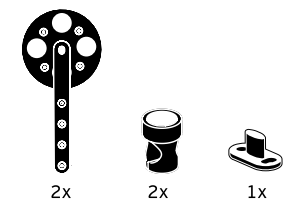

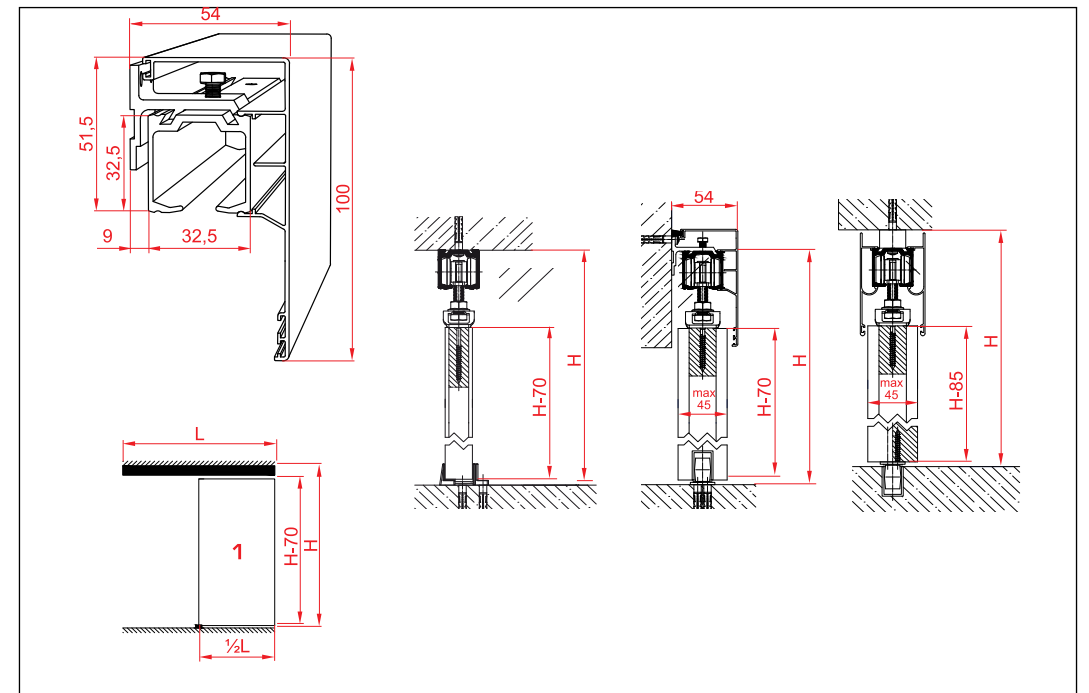
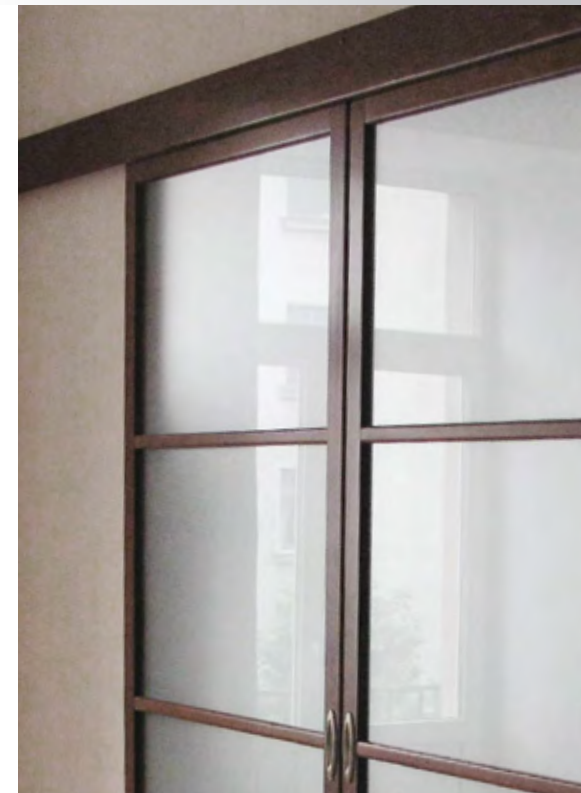
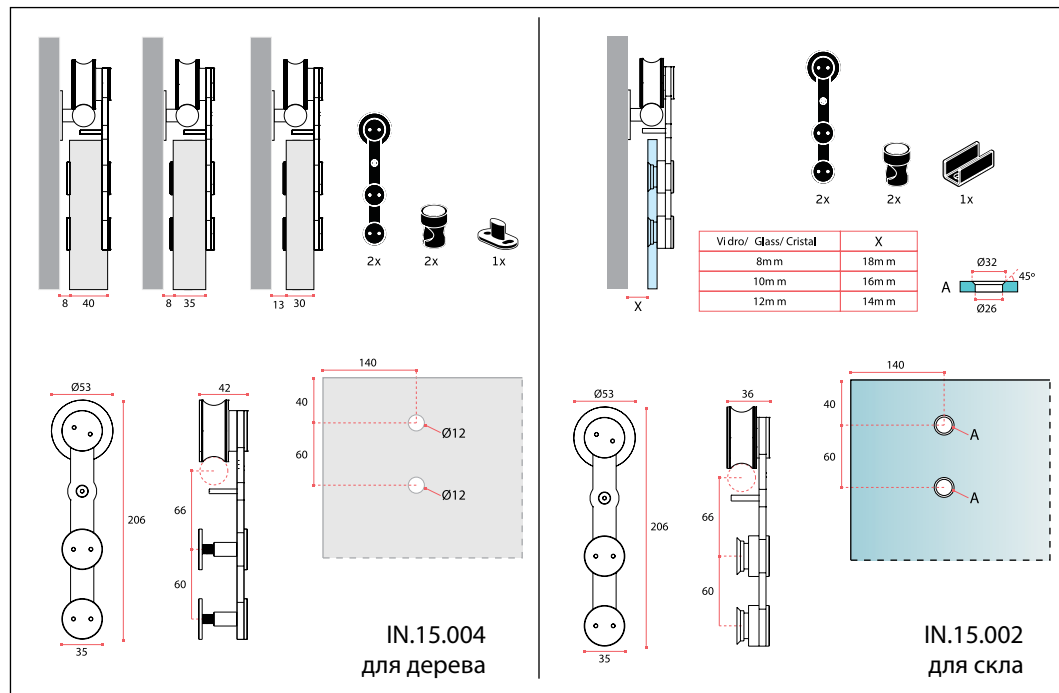





хром матовий

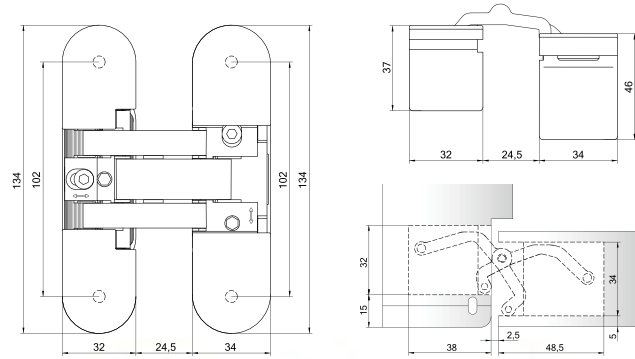

латунь



білий



нікель матовий

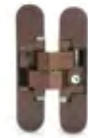

бронза



чорний



хром полірований



хром матовий  
та нікель матовий

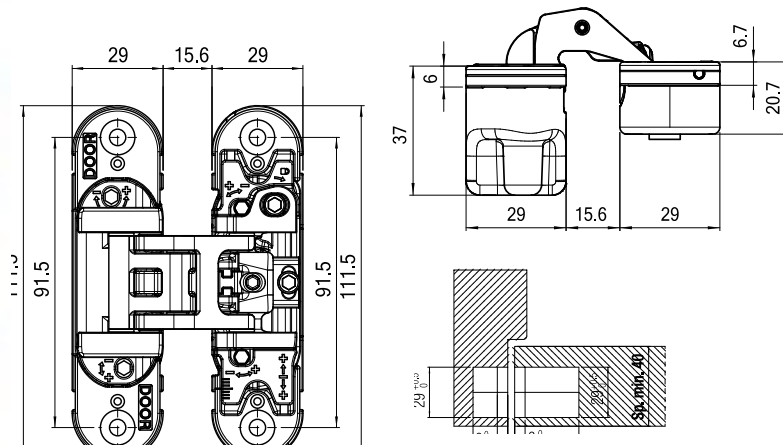

Otlav 495 d14

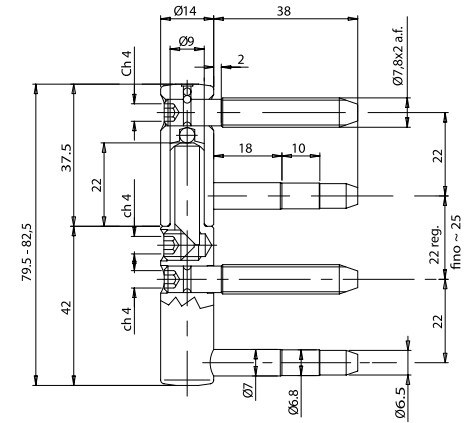

Otlav 495 d16

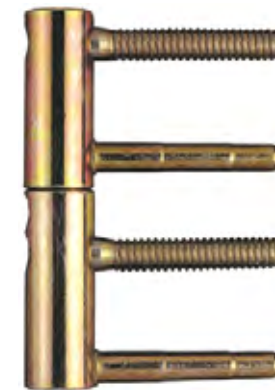
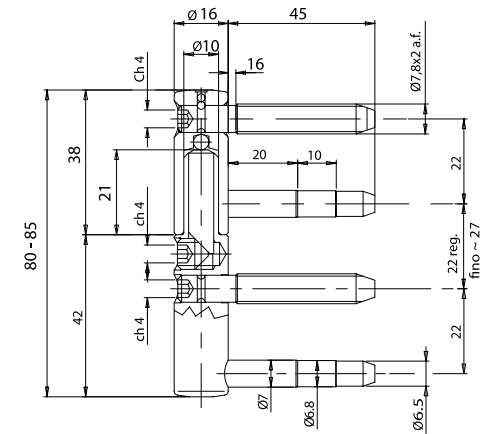

Otlav 495 d20

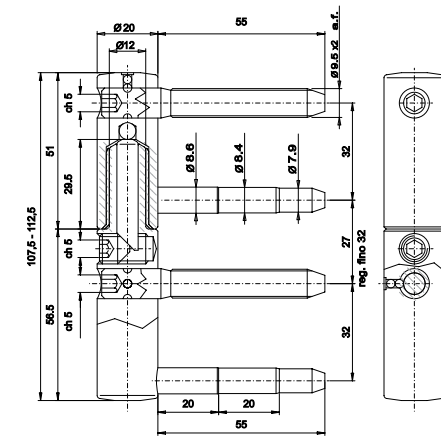



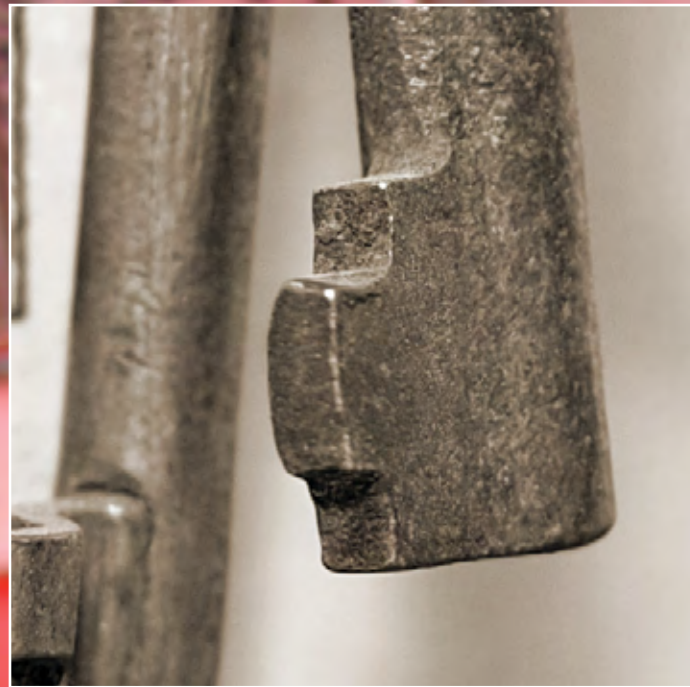
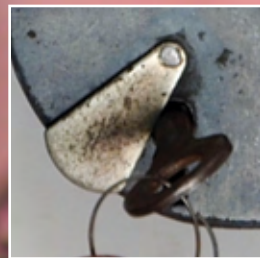





стенд рухомий  
181 x 30 x 120 см



стенд настільний  
36 x 25 см, основа 20 x 25 см



стенд навісний  
98 x 30 x 8 см

-  01 | латунь
-  03 | хром
-  16 | неіржавіюча сталь
-  46 | антична бронза
-  47 | античне срібло
-  49 | чорний нікель
-  51 (відповідає 141) | титан з сатином
-  52 (відповідає 142) | нікель матовий з сатином
-  58 | полірована неіржавіюча сталь
-  77 | бронза
-  96 | хром матовий
-  128 (відповідає 153) | чорний з сатином
-  141 | титан
-  142 | нікель матовий
-  152 | білий
-  153 | чорний

-  IN.00.000 | натуральний титан з неіржавіючої сталі
-  IN.00.000P | неіржавіюча сталь полірована
-  IN.00.000TB | чорний титан з неіржавіючої сталі
-  IN.00.000TCO | титан міді з неіржавіючої сталі
-  IN.00.000TG | золото титан з неіржавіючої сталі

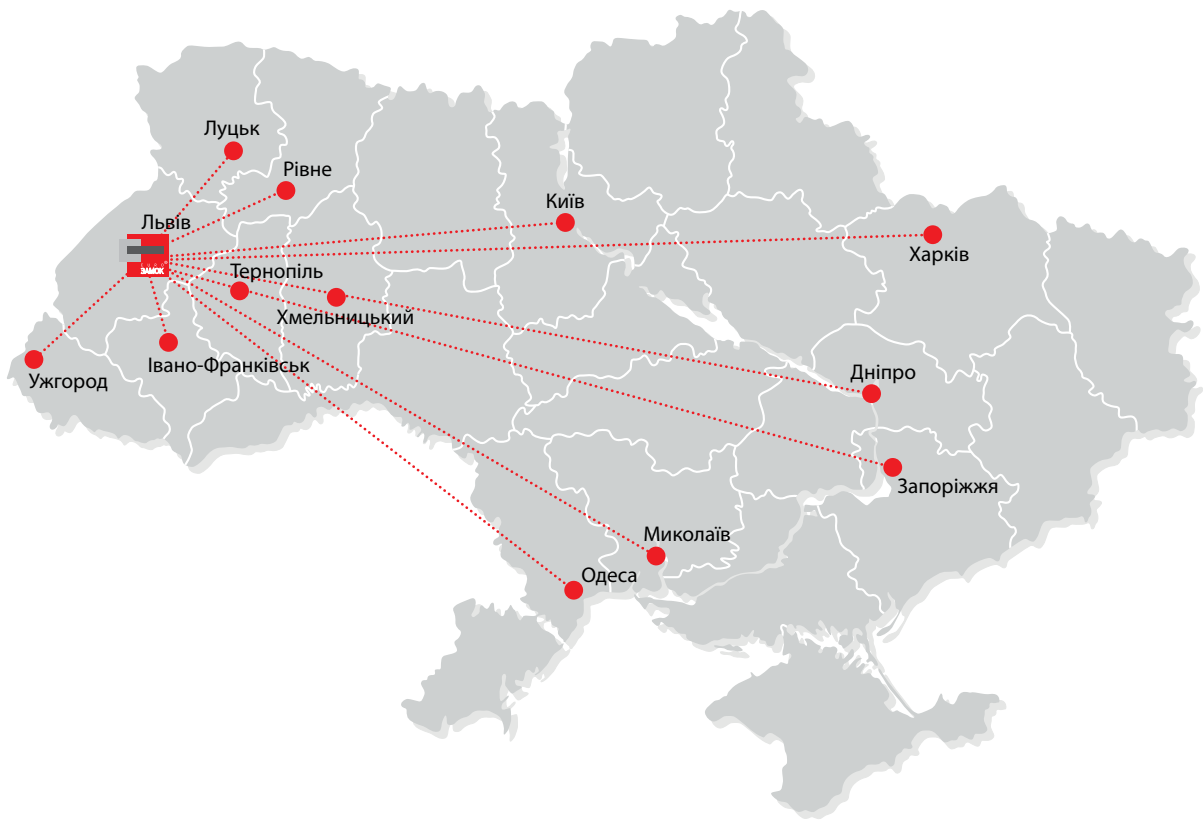

[www.eurozamok.ua](http://www.eurozamok.ua)

